

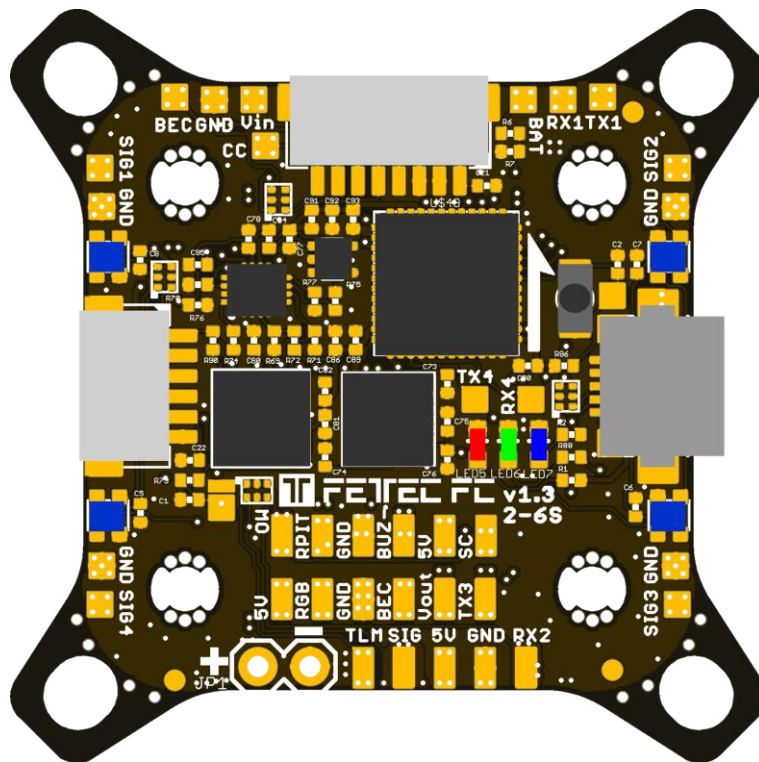

# FETtec FC G4

## Manual



Introduction .....	3
Features .....	3
Safety warning .....	4
Recommended steps for installation of the FETtec FC G4 .....	4
Connection Diagram .....	5
Connection Layout top.....	5
Connection Layout bottom.....	6
ESC connection diagram .....	8
ESC connection via 8 pin connector.....	8
Single ESC connection diagram.....	9
Other brand ESC connection.....	10
Receiver connection diagram.....	11
TBS Crossfire .....	11
SBUS receiver / FrSky R-XSR .....	11
Analog FPV connection diagram.....	12
Digital FPV connection diagram.....	13
DJI/Caddx/Runcam Vista FPV system .....	13
Fatshark Shark Byte system.....	14
Caddx Walksnail.....	15
DJI O3 unit .....	16
FC configuration.....	17
KISS FC firmware.....	17
FC firmware update .....	18
OSD.....	19
Settings .....	19
Issues in the picture .....	21
Move elements in the OSD menu .....	21
FETtec Alpha FC firmware .....	22
Get back to KISS .....	25
FC firmware update .....	27
Settings.....	28
OSD.....	29
Update.....	29
Settings .....	30
Display connection.....	32
Activation in FETtec Alpha FC firmware .....	33
Dimensions .....	34

## Introduction

Thank you for purchasing the FETtec FC G4.

## Features

- Latest STM32G4 Processor
  - 170Mhz + Math accelerator
  - MPU6000
- Supply voltage 6-27V (2S-6S Lipo)
- 2x dedicated onboard BEC (max. 600mA each)
  - 5V BEC for RX
  - 5V/16V BEC for VTX (switchable and real Pit\*)
- 2x 8 pin connector for solder free ESC connection
  - Connector 1: ESC signal 1-4, telemetry, VCC, GND
  - Connector 2: ESC signal 5-8 (depending on UAV type 1-4), telemetry, VCC, GND
- 1x 8 pin connector for solder free VTX, cam connection and OSD or digital systems
  - real Pit\* VCC, GND, Video in, Video out, BEC 5V/16V, VCS/TX3, RX3
- 2x 6 pin connectors for serials
  - RX1, TX1, 3.3V, VCC, 5V, GND
  - RX3, VCS/TX3, RGB LED, VCC, 5V, GND
- 1x 4 pin connector for receiver
  - Signal, TLM, 5V, GND
- 5 UART serials
  - UART 1 free
  - UART 2 used for Receiver
  - UART 3 free
  - UART 4 used for onboard OSD, can be set free
  - UART 5 used for ESCs / TLM / Onewire
- 4 ESC solder pads (Signal/GND) in each corner
- Buzzer pads
- 4 tiny RGB LEDs (selectable color)
- Supported ESC protocols
  - PWM, Oneshot125, Oneshot42, Dshot150/300/600/1200/2400, FETtec Onewire
- FETtec KISS firmware
- Onboard OSD
  - Graphic OSD (STM32)

- Full KISS Tuning
  - Filter (PIDs, Rates, Settings)
  - LED control (RGB LED, Racewire)
  - VTX
  - Live data graphs (Voltage, motor rpm, current, motor temp, gyro values, link quality)
  - KISS GPS support + live map
  - Custom graphic pilot logo
  - Stick overlay
  - Custom layout
  - can be deactivated for usage of digital systems
- Maximum outside dimensions: 37,2 x 37,2mm, without outside tips 30 x 30mm
    - Mounting hole arrangement:
      - 20 x 20mm with M2 mounting hole (expandable to M3)
      - 30 x 30mm with M3 mounting hole
      - 30 x 30mm mounting hole tips are removable to reduce overall FC size
  - Overall height: 7,9mm
  - Weight: 5,37g
  - Connector type: JST-SH-1mm

\*real Pit-Mode: A power supply pin which is remotely switchable

### **Safety warning**

- Remove propeller before flashing and configuration
- always flash latest firmware before operation

### **Recommended steps for installation of the FETtec FC G4**

- Connect to FETtec Configurator and update to the latest firmware (see FC firmware update)
- Install the FC in your copter (see Connection diagrams for correct wiring and installation)
- Make sure everything is connected properly and check without propellers
- Connect to KISS GUI to proceed with final configuration of the FETtec FC G4 (FC configuration)

## Connection Diagram

### Connection Layout top

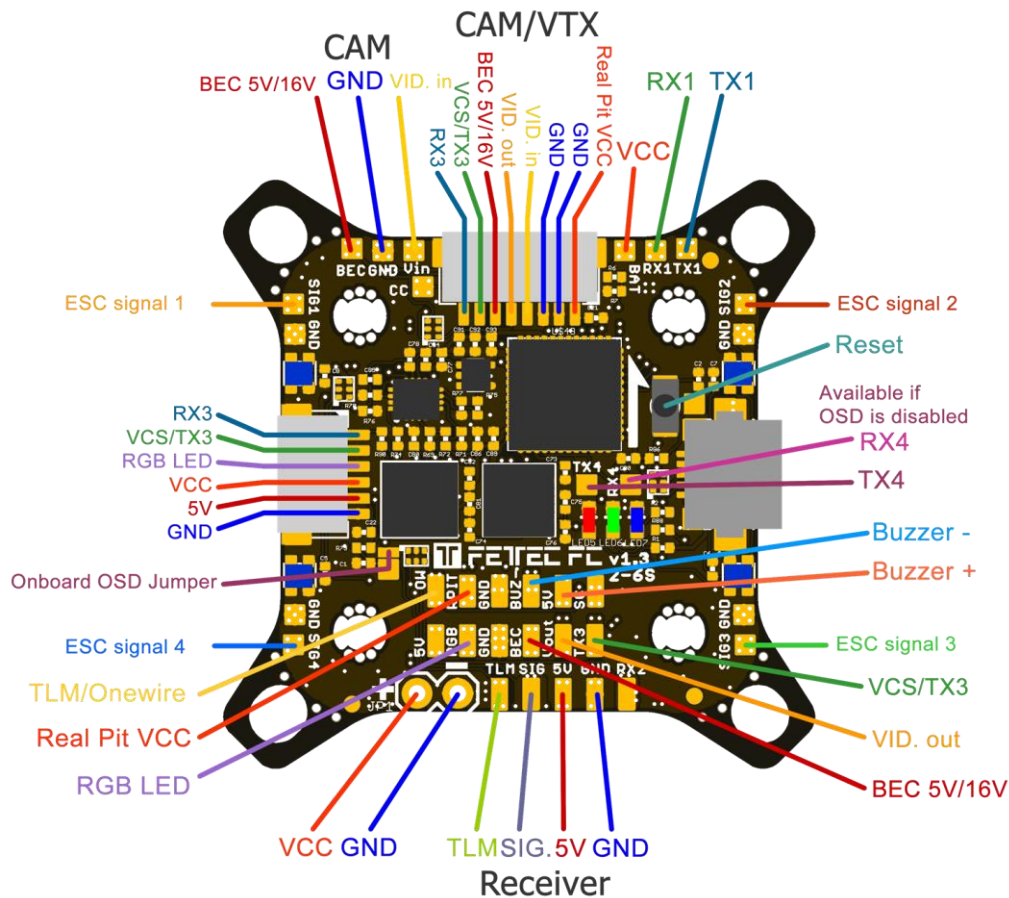

The 8 pin connector combines all necessary connections for analog or digital VTX and camera. It includes:

- Real Pit VCC (Lipo+)
- GND for cam and VTX
- Video in: Analog video signal from cam
- Video out: Analog video to VTX
- BEC 5V/16V: power supply for cam and/or VTX, switchable voltage, real Pit capable
- VCS/TX3: for smart audio / tramp configuration or TX for digital FPV systems
- RX3: for digital FPV systems

6 pin connector (SER3):

- RX3: for digital FPV systems or other functions configurable in GUI (same for VCS/TX3)
- VCS/TX3: for smart audio / tramp configuration or TX for digital FPV systems
- RGB LED: PWM signal pin to control WS2812 LEDs or similar (configurable in GUI)
- VCC: Battery voltage
- 5V
- GND

## Connection Layout bottom

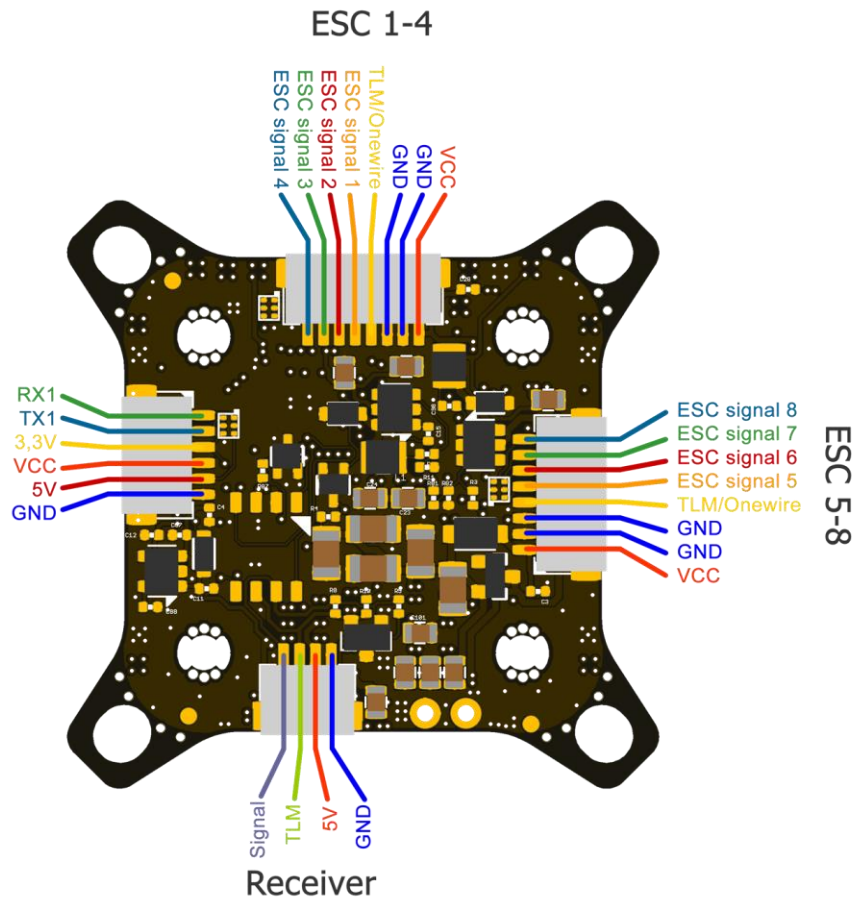

### 8 pin ESC connector 1:

- VCC: Battery voltage out to supply FC power
- GND
- TLM/Onewire: ESC Telemetry signal to FC or Onewire signal pin (depending on configuration)
- ESC signal 1-4: ESC signal output for each ESC

### 8 pin ESC connector 2:

- VCC: Battery voltage out to supply FC power
- GND
- TLM/Onewire: ESC Telemetry signal to FC or Onewire signal pin (depending on configuration)
- ESC signal 5-8: ESC signal output for each ESC (outputs ESC signal 1-4 if UAV type is configured as BI, TRI, QUAD)

#### Receiver connector:

- GND
- 5V
- TLM: Telemetry signal to receiver (see page 10 receiver connection diagram for further information)
- Signal: Receiver signal to FC (see page 10 receiver connection diagram for further information)

#### 6 pin connector (SER1):

- RX1: function configurable in GUI
- TX1: function configurable in GUI
- 3,3V
- VCC: Battery voltage
- 5V
- GND

#### Acronym explanation:

- BEC 5V/16V: switchable voltage (in GUI) and real Pit capable
- GND: Reference Signal Ground
- Onboard OSD Jumper: bridge to deactivate onboard OSD and to activate RX4 and TX4
- Real Pit VCC: real Pit capable VCC pin
- Reset: Reset button to force the FC in bootloader mode, not needed for normal operation
- SIG.: receiver signal (serial)
- TLM: Telemetry signal output for receiver (Serial)
- TLM / Onewire: ESC telemetry input or Onewire signal depending on configuration
- VCC: Battery input voltage (6V-27V)
- VCS: Video control signal (smart audio/tramp)
- VID. in: Analog video signal to OSD
- VID. out: Analog video signal from OSD

## ESC connection diagram

### ESC connection via 8 pin connector

For easy ESC connection via 8 pin cable

FETtec FC G4 to FETtec 4in1 ESC 45A (same for FETtec 4in1 ESC 35A), cable included with FETtec ESCs.

Any other ESC is usable (please make sure the signal pinout is correct, otherwise change accordingly)

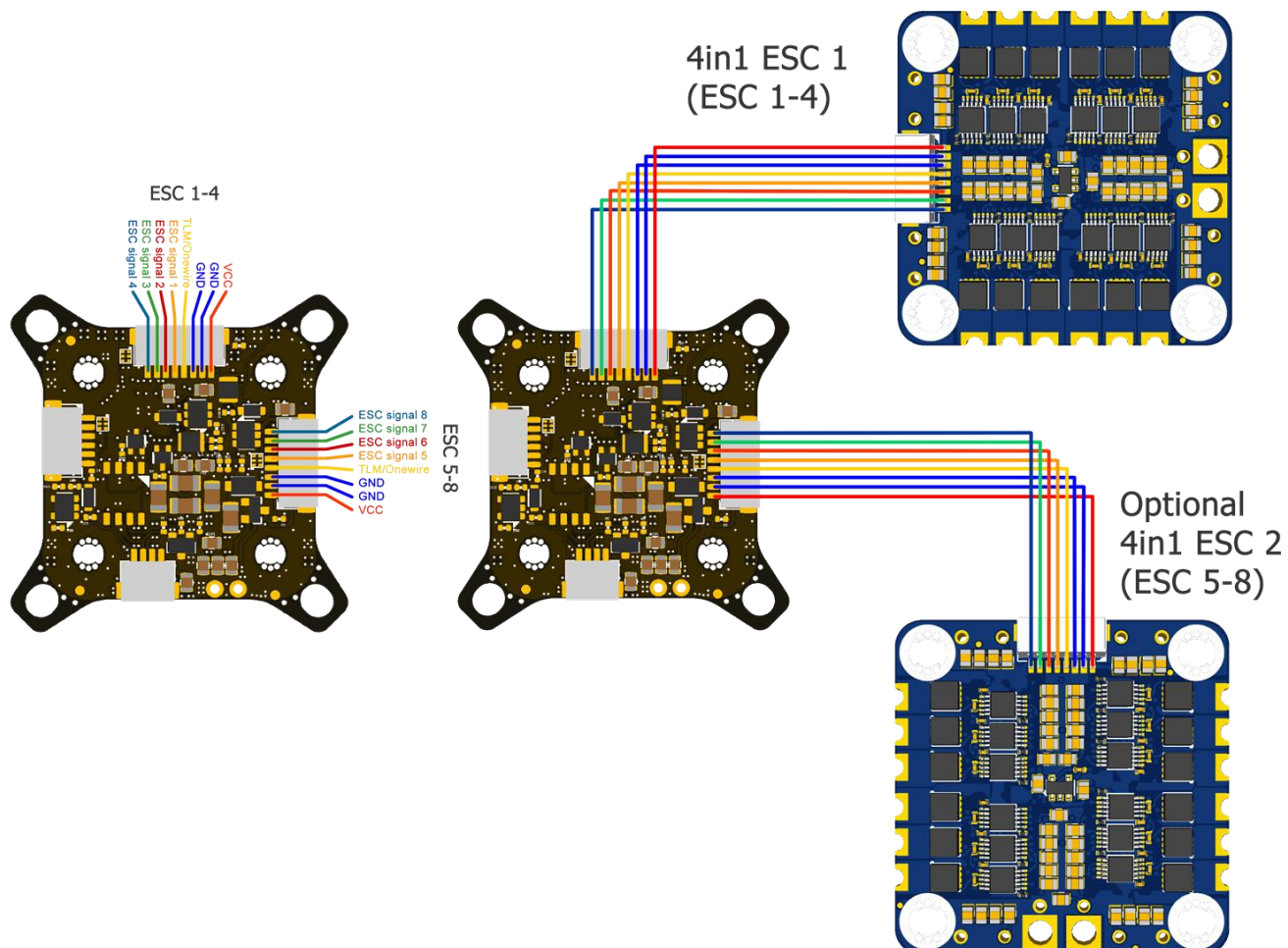



## Single ESC connection diagram

The FETtec FC G4 provides 4 ESC signal pads for solder connection of single ESCs

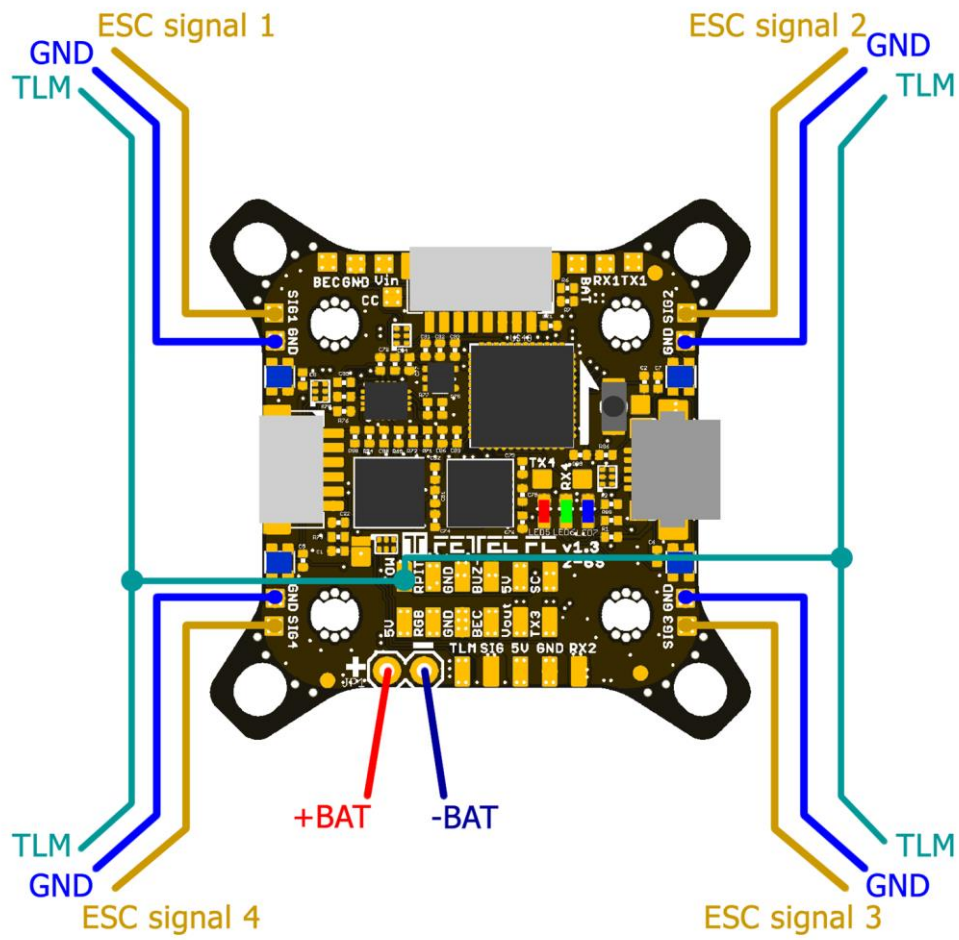

## Other brand ESC connection

If you use another ESC as FETtec you have to connect current senso to the SC pad on the FC

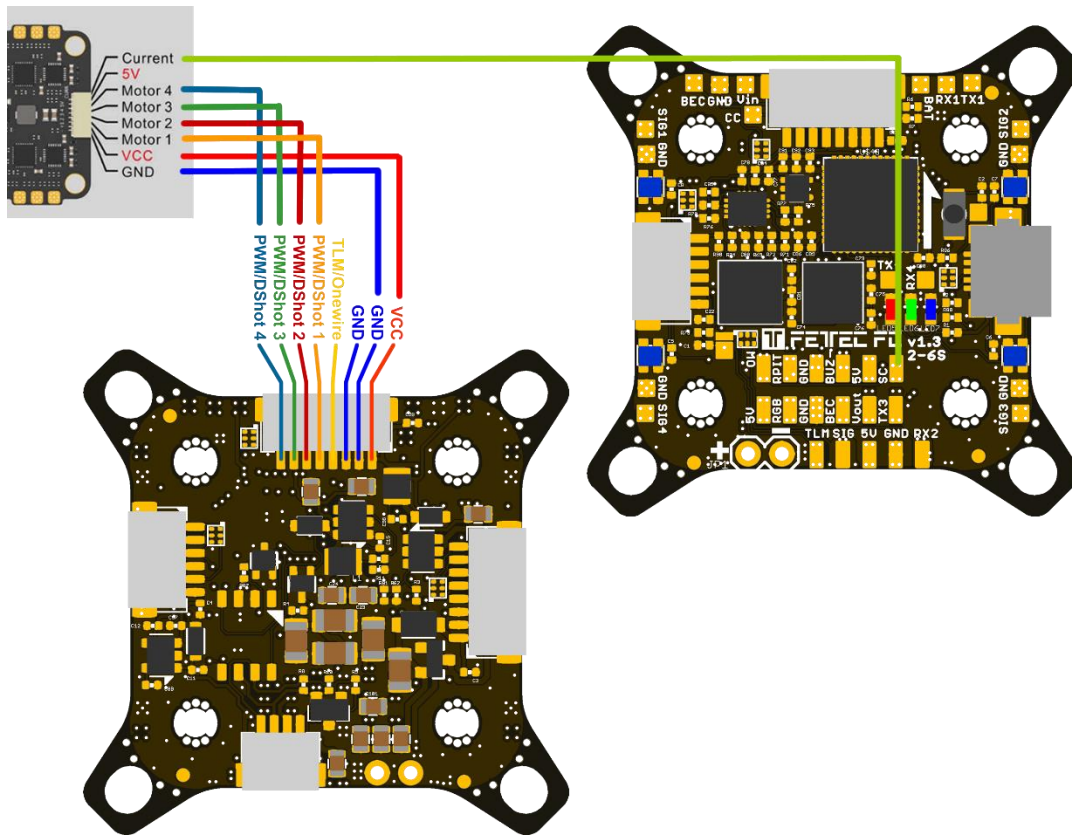

Ensure the power polarity connected correct.

The motor mapping for FETtec ESCs is different, please check and remap.

Press load and then save to take the settings over.

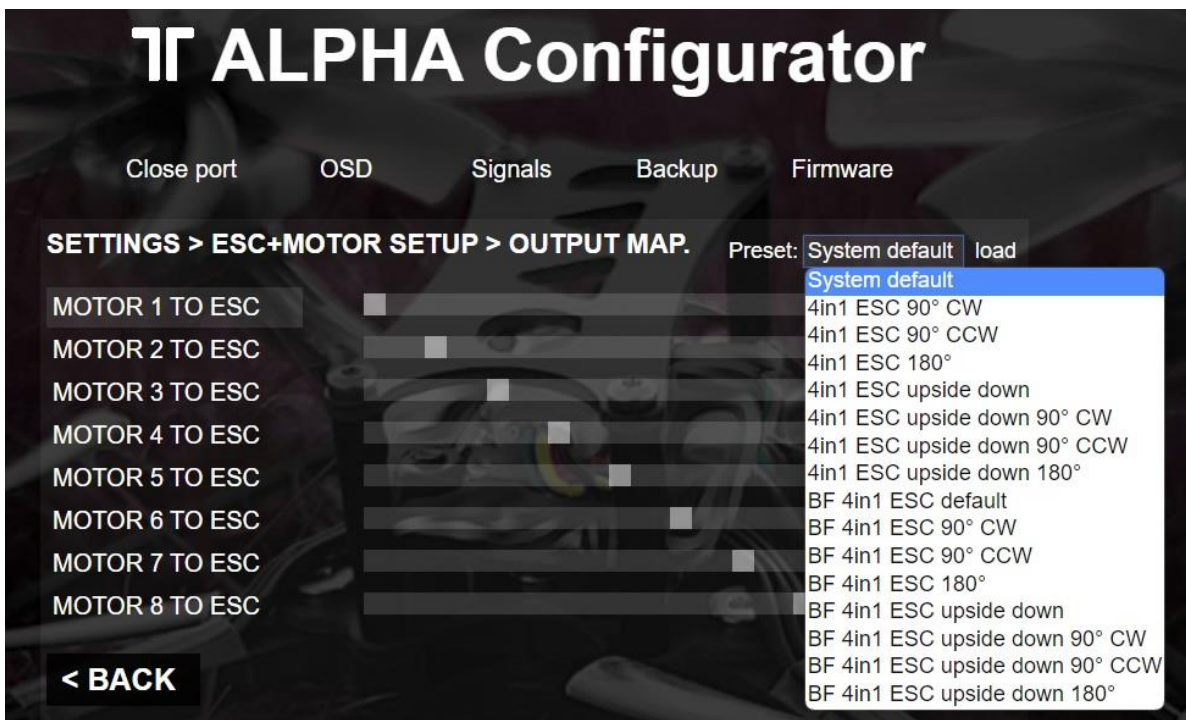

## Receiver connection diagram

Receivers can be connected via receiver connector (on bottom side of FC) or receiver solder pads (on top side of FC)

### TBS Crossfire

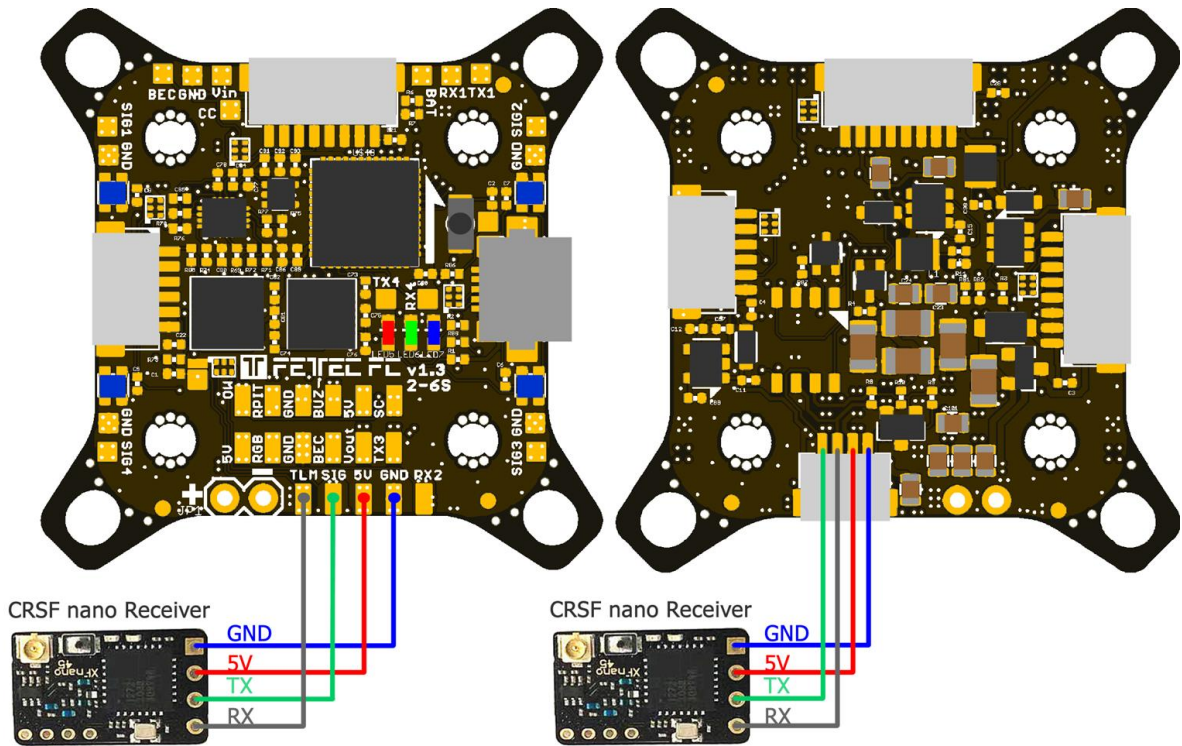

### SBUS receiver / FrSky R-XSR

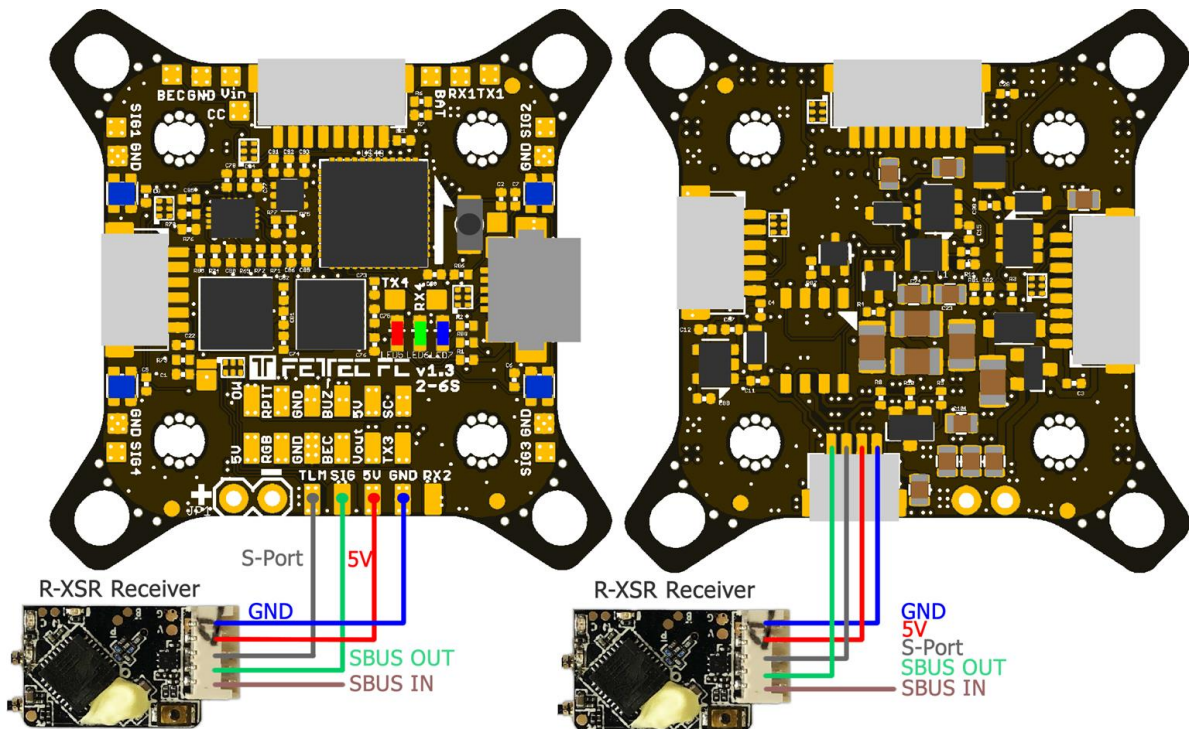

## Analog FPV connection diagram

VTX and cam can be connected via FPV connector (on top side of FC) or FPV solder pads (on top side of FC)

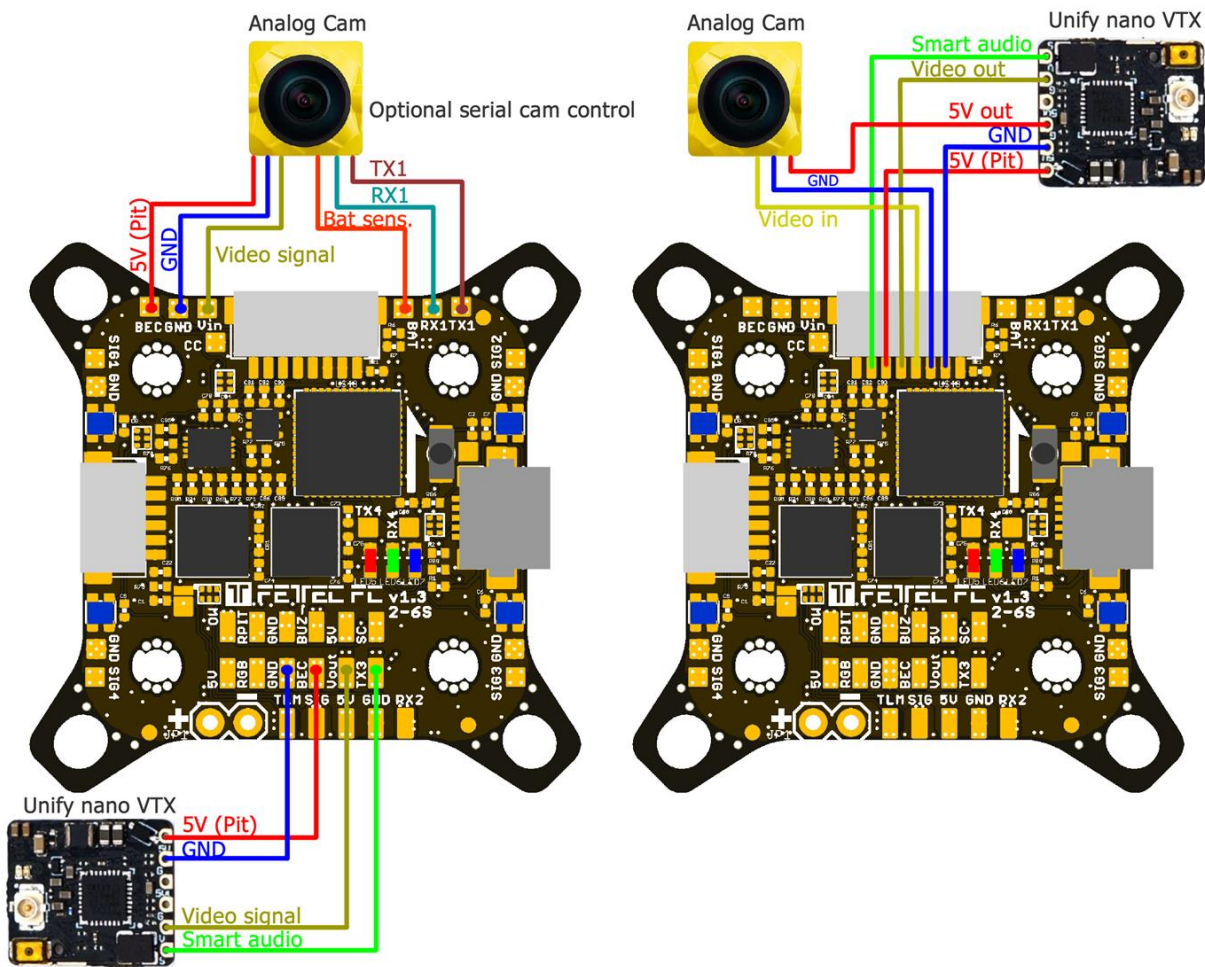

Notes:

RX and TX connection is only used for cameras which support serial connection.

A unit's transmit signal (TX) must match the corresponding receiver (RX) at the other end. It must therefore be wired crosswise in order to transmit a signal.

## Digital FPV connection diagram

Choose MSP Port on serial 3 in the FETtec ALPHA Configurator → Settings → FC setup → Serial or KISS GUI

### DJI/Caddx/Runcam Vista FPV system

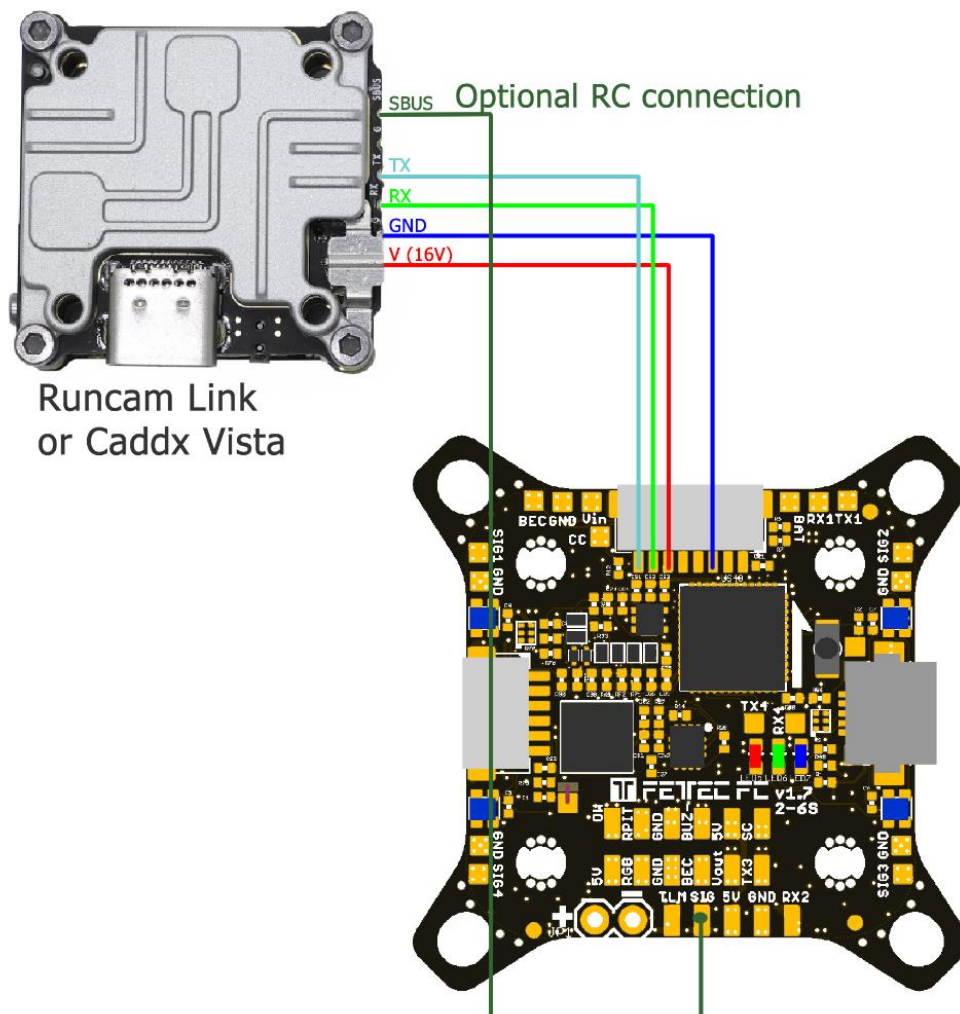

# Fatshark Shark Byte system

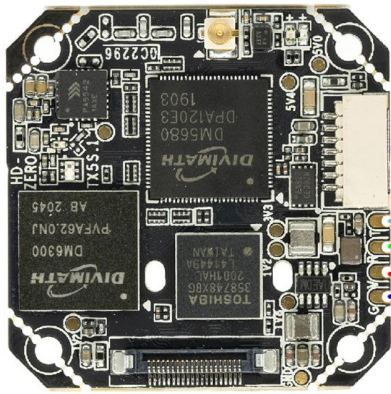

Shark Byte VTX

TX  
RX  
V (7-26V - Bat)  
GND

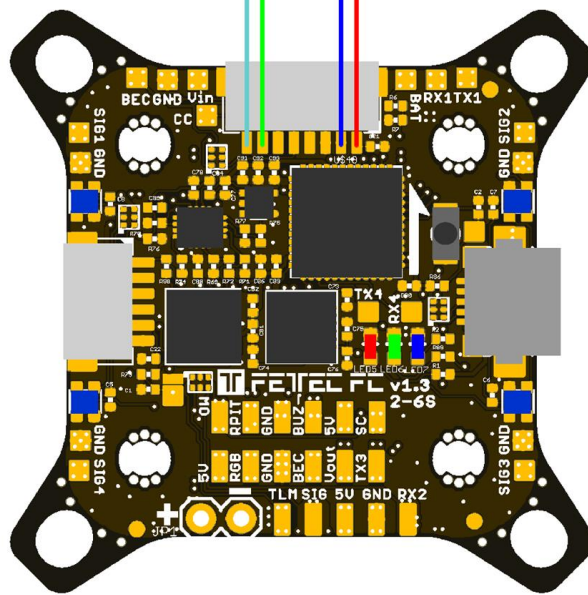

# Caddx Walksnail

# Walksnail AVATAR

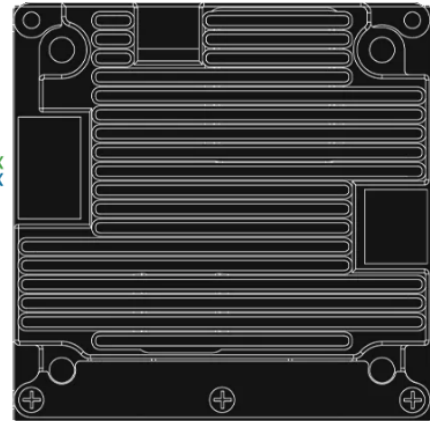
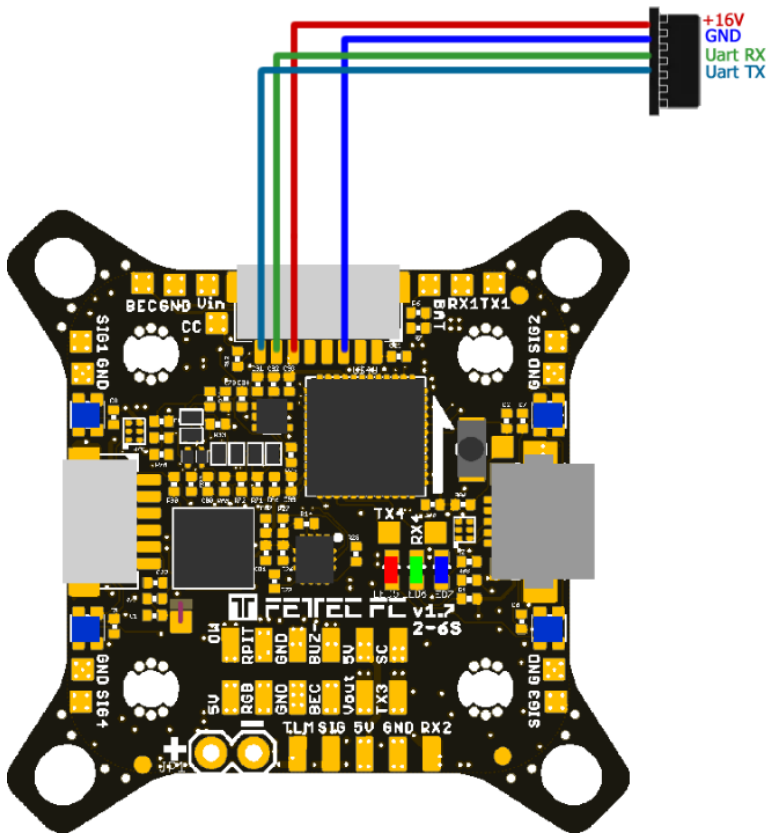

# DJI O3 unit

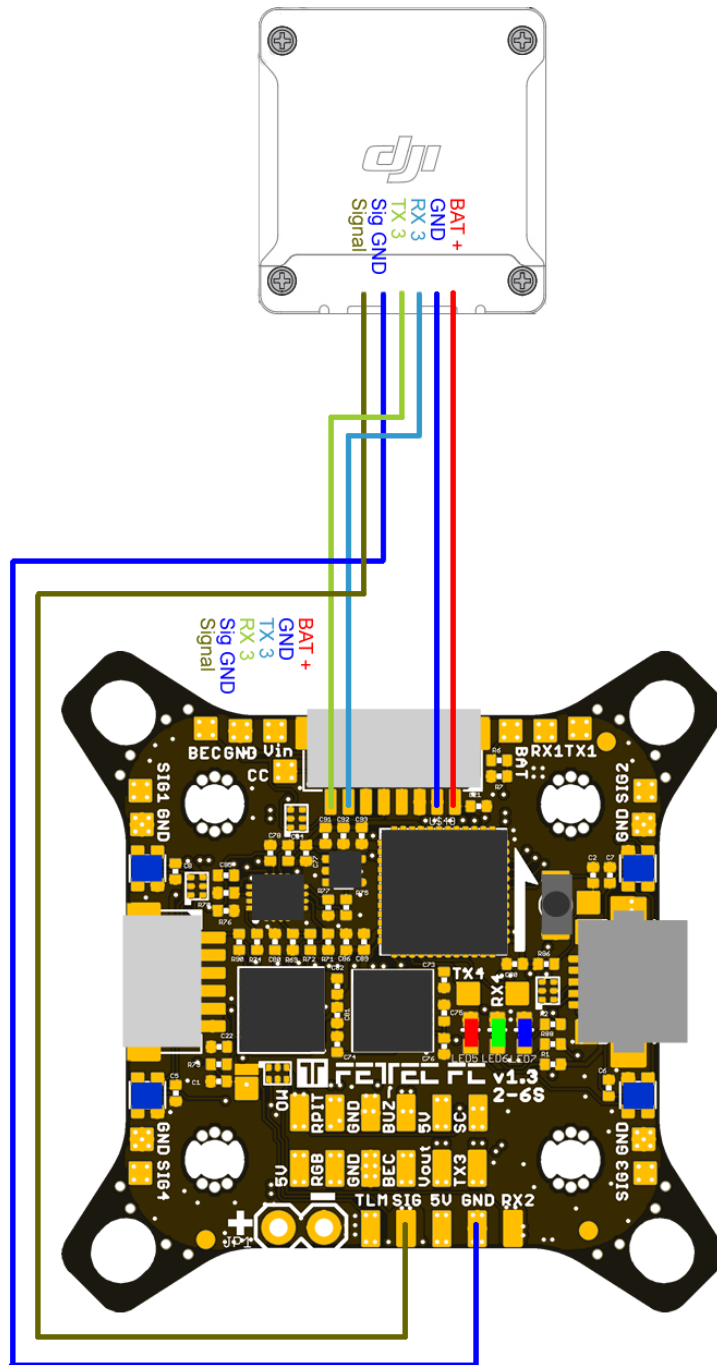



## FC configuration

### KISS FC firmware

Download KISS GUI: <https://github.com/flyduino/kissfc-chrome-gui/releases>

After installing the KISS GUI connect the FETtec FC G4 via USB. Open the KISS GUI and select the serial port on which the FC shows up and press connect.

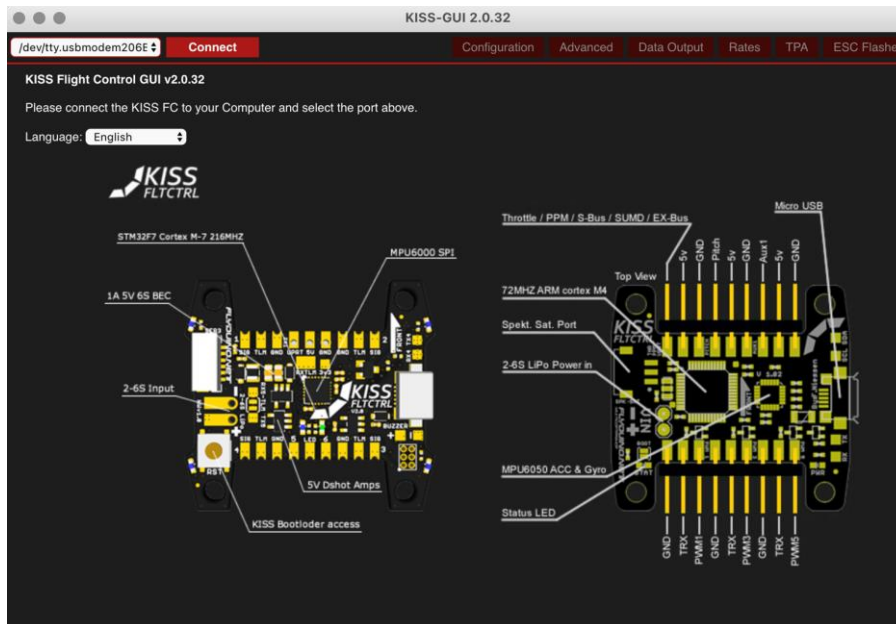

Activate the FETtec FC G4 in the KISS GUI by pressing activate on the following prompt

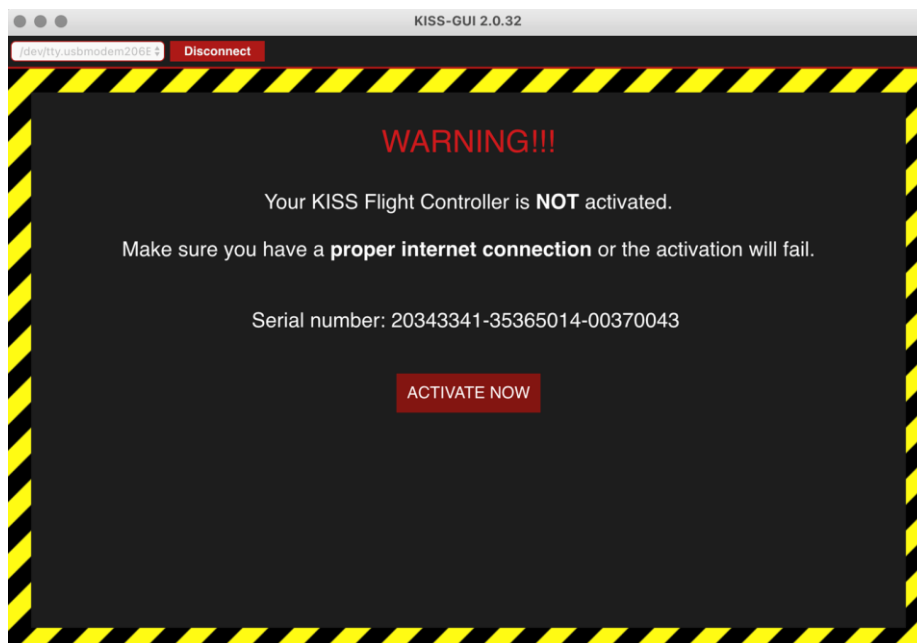

Now you can set up the FC according to your wishes. To ensure that your settings are not getting lost, use the backup function by pressing the button "backup" and saving the configuration as a text file.

## FC firmware update

1. Open FETtec Toolset <https://gui.fettec.net>  
The FETtec ESC Configurator is also available as download version here: <https://github.com/FETtec/ESC-Configurator>
2. Open the FETtec ESC Configurator
3. Connect the FETtec FC via USB
4. choose USB and select the correct COM Port and press connect.

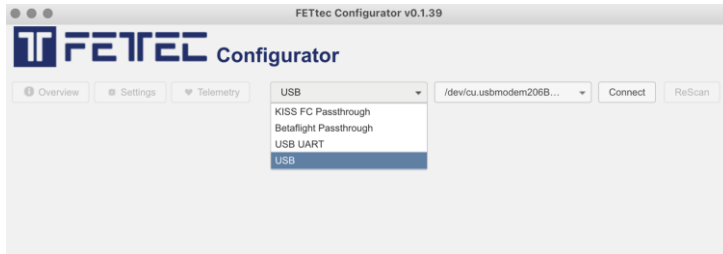

5. You should see the FETtec FC G4 as shown.



6. Click “Remote Firmware” button and select the latest available firmware.
7. Press “Flash selected!”

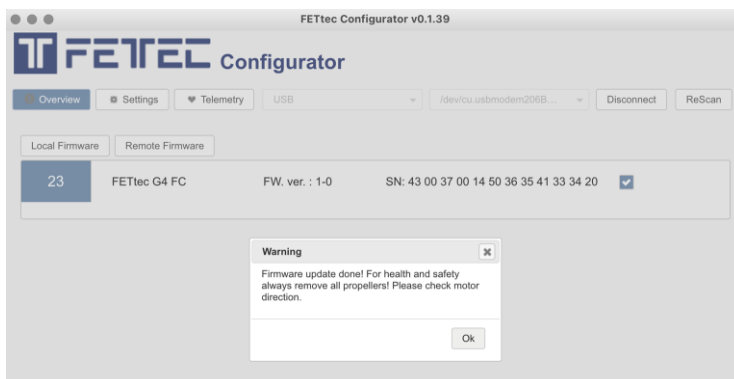

FC is flashed now!

Settings can be made in the KISS GUI.

We recommend to always use the latest available firmware to get the best user experience.

If you like to try new features and firmware developments you can join our Discord channel and download the latest beta firmware to try on your own risk (<https://discord.gg/pfHAbahzRp>)

# OSD

**Please update the FETtec OSD Board before your first flight !**

To update the FETtec OSD connect to FETtec Configurator and flash via FC passthrough latest firmware.



## Settings

All settings can be set up directly in the OSD

To get in the menu move the sticks in the shown direction at the start:

Throttle 50%, then move Yaw left, Pitch up

Mode 1:

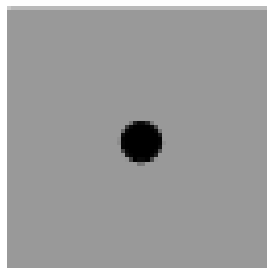
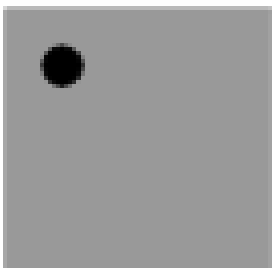

Mode 2:

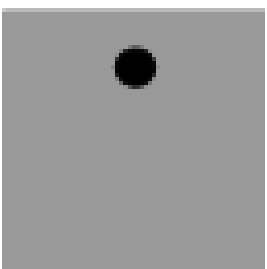
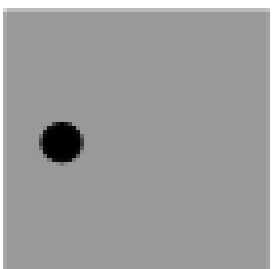

In the menu:



OSD settings:



## Issues in the picture

1. OSD SYNC → AUTO SYNC
2. in case of unsharp lines play with LEFT/WITH values try to avoid WITH values above 400
3. make a PAL/NTSC layout reset

## Move elements in the OSD menu

Choose LAYOUT → SET POSITIONS in the SETTINGS.

Now the elements are movable along the grid.

Skip between the elements and select them to set new position.

**To exit the ´move menu´ hold stick Yaw left for a few seconds**

## FETtec Alpha FC firmware

The FETtec FC G4 is able to use FETtec Alpha FC firmware. For install:

1. Open FETtec Toolset <https://gui.fettec.net> and choose ALPHA Configurator.
2. Connect the FETtec FC via USB.
3. Open the ALPHA Configurator and select open port. Choose the serial port on which the FC shows up and press connect.

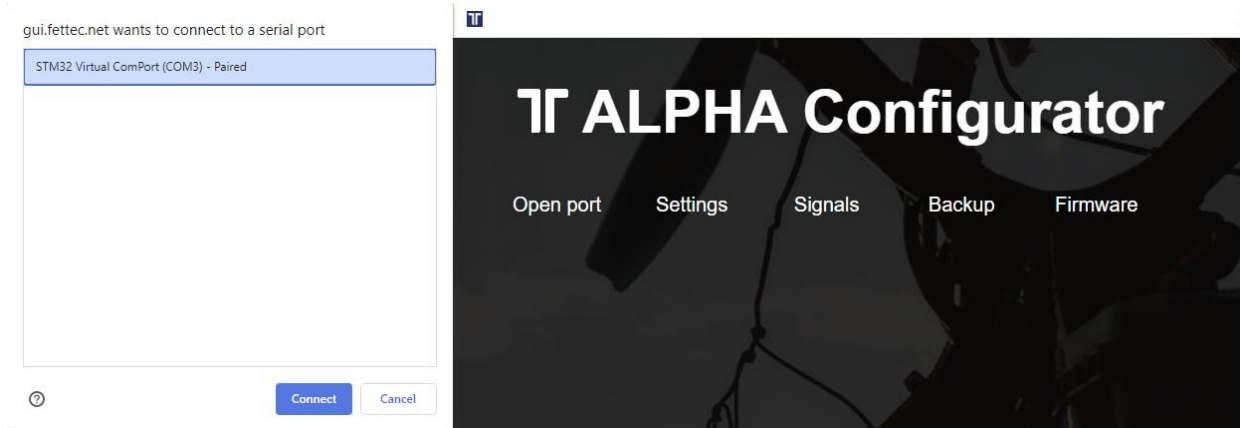

4. If you have KISS FC firmware running on your FC, you will get a warning if you want to flash FETtec Alpha FC firmware. Press "OK"

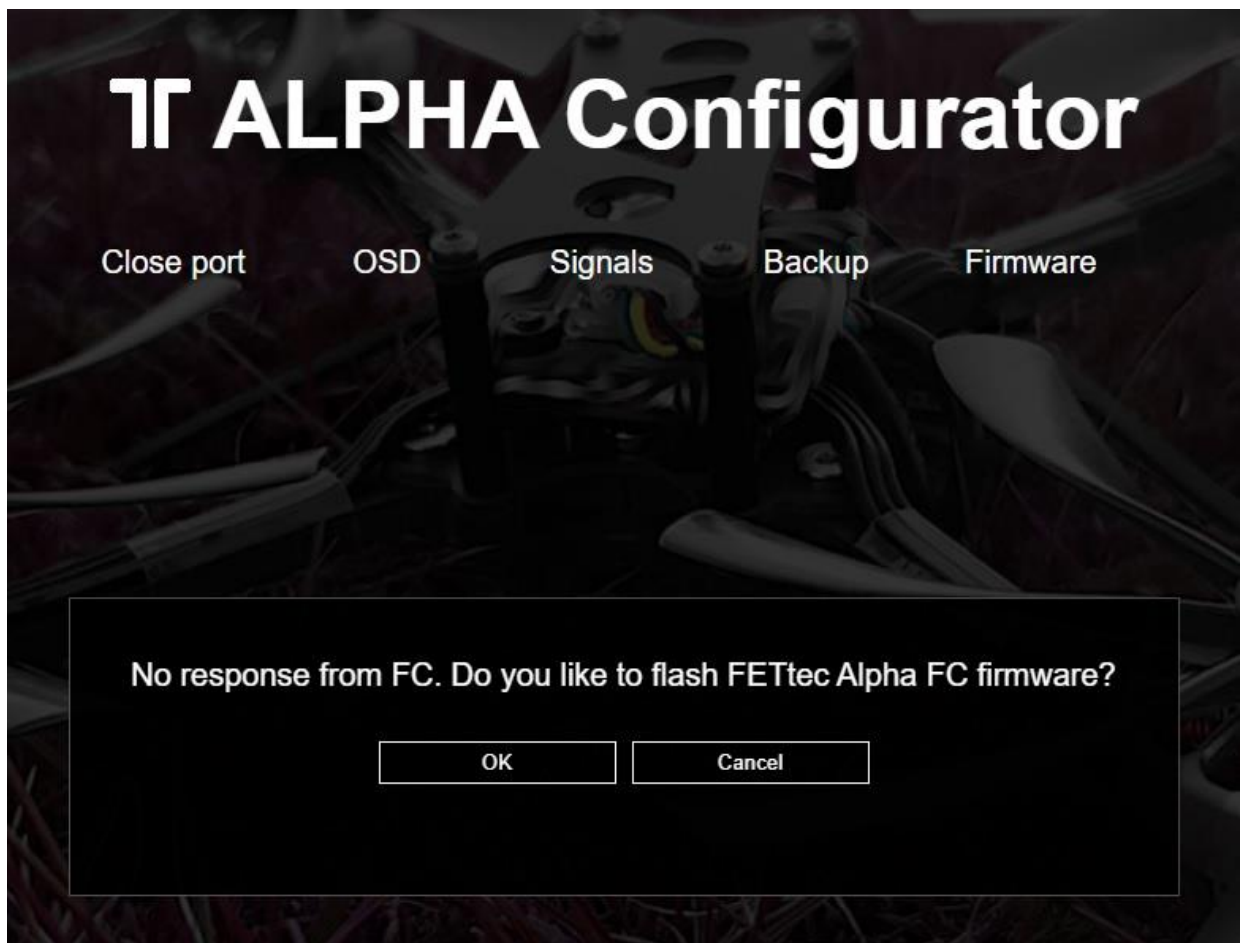

Select serial port again

5. "Select new firmware to flash".

We always recommend flashing the latest available firmware.



6. Confirm to flash FETtec ALPHA firmware by pressing "OK"

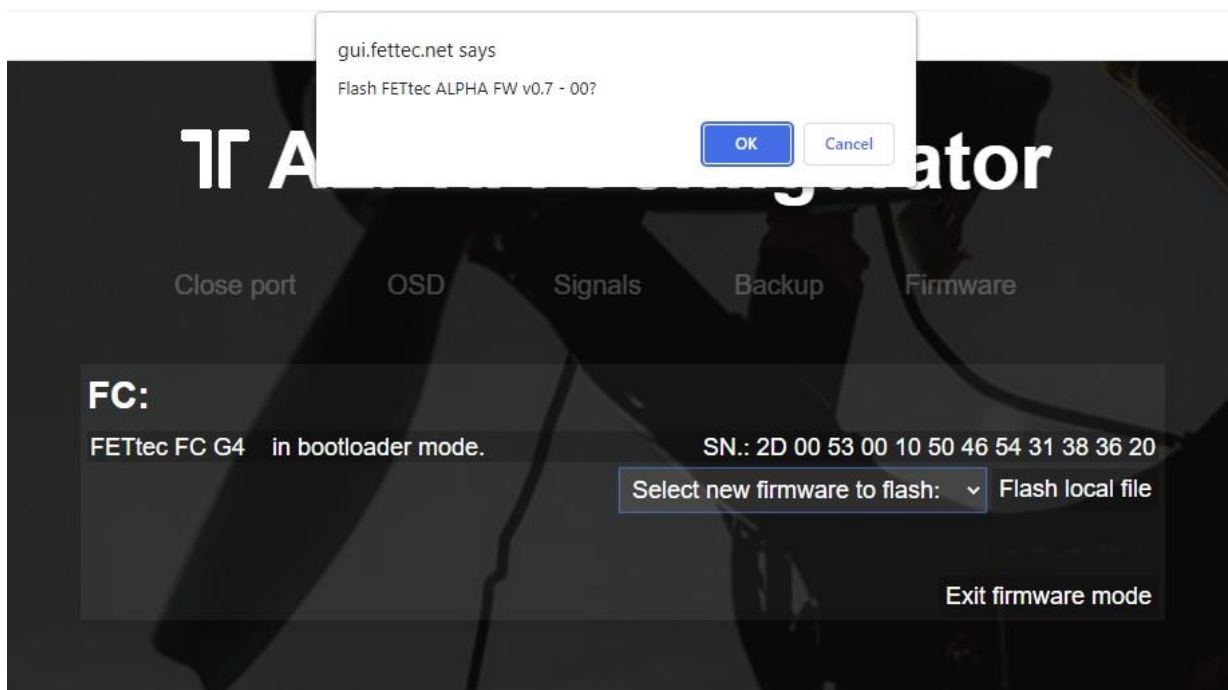

7. FC firmware update is done!

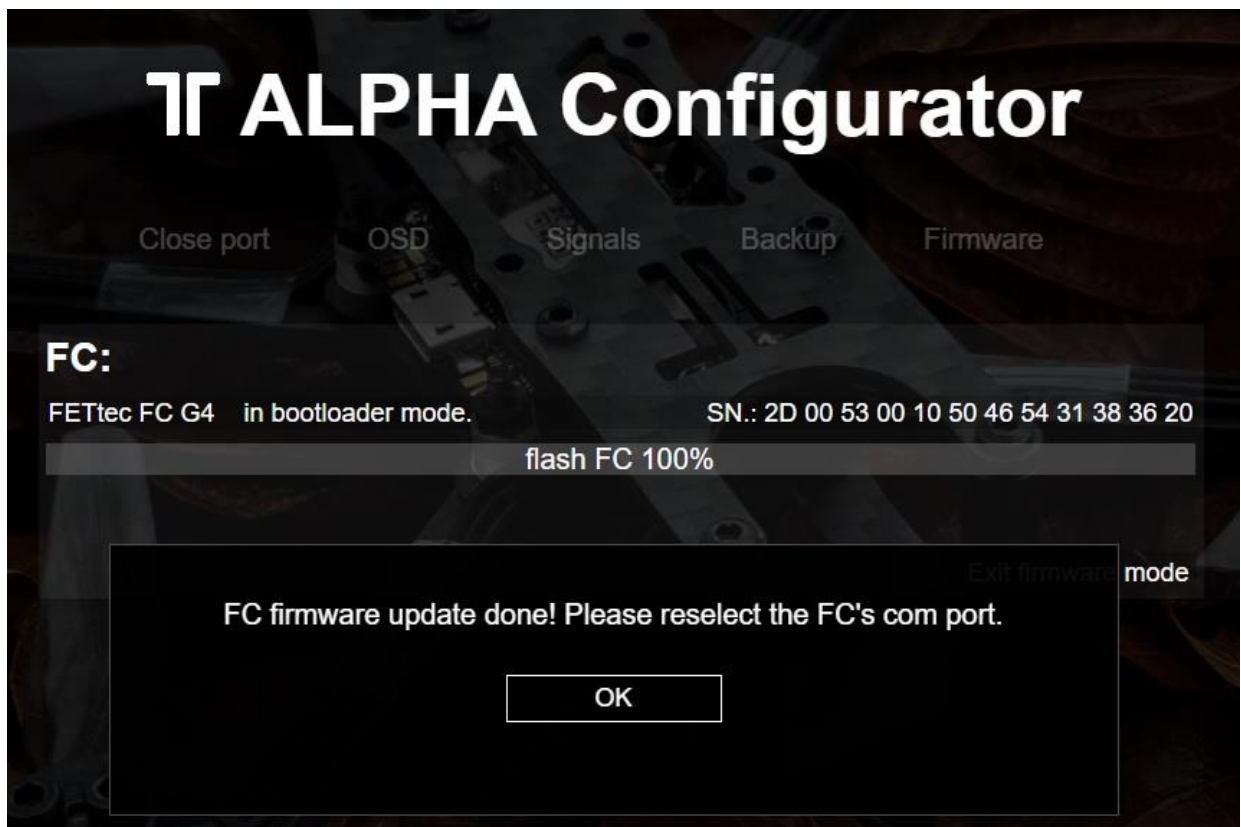

The FC needs a restart after that, therefore the com port is requested to be selected and connected again

Now you can customize everything in the GUI according to your wishes.

Please connect everything like described in the manual of the FC.

A unit's transmit signal (TX) must match the corresponding receiver (RX) at the other end. It must therefore be wired crosswise in order to transmit a signal.

The receiver signal will get auto detected (supported systems are Frsky Sbus+S-Port, CRSFv2 and CRSFv3 and Ghost).



## Get back to KISS

If the FETtec Alpha FC firmware is flashed on your FC and you want to get back to KISS firmware, follow these steps:

1. Open FETtec Toolset <https://gui.fettec.net/>
2. Connect the FETtec FC via USB.
3. Press the reset button once
4. Open the FETtec **ESC** Configurator and select “USB” and connect.
5. Choose the serial port on which the FC shows up and press connect.

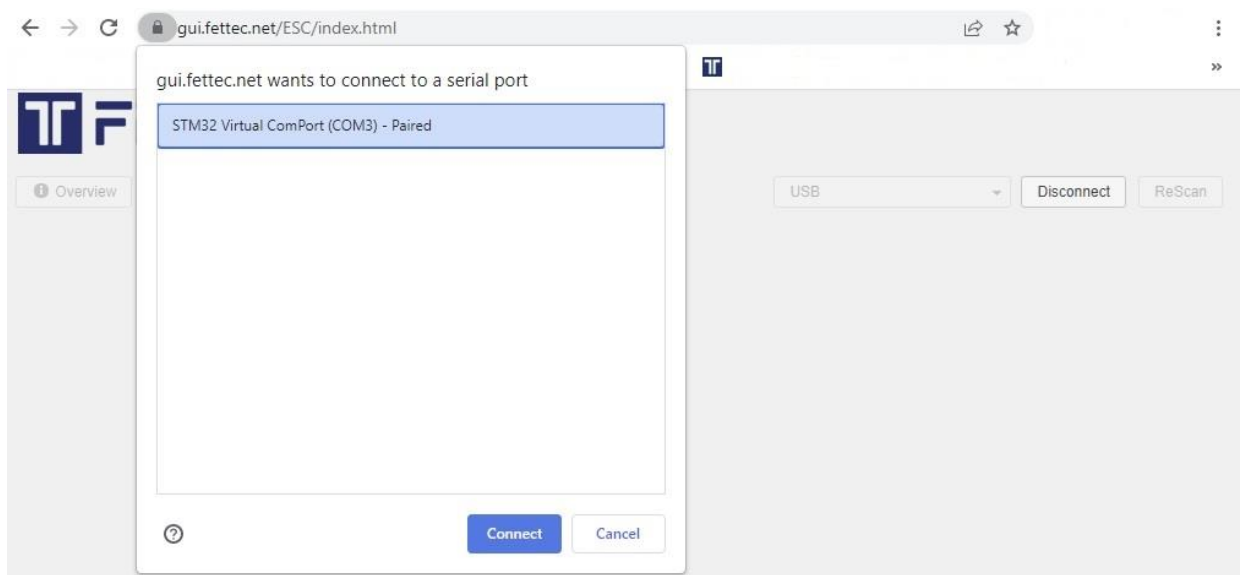

6. Now the FC shows up and you can select KISS Firmware (FETtec FC G4 1.3-RC47i or later) in “Remote Firmware” and press “Flash selected!”

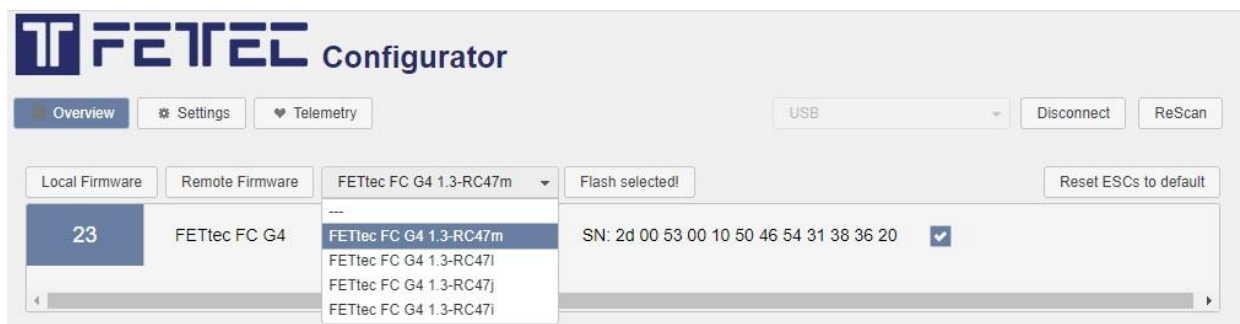

7. Flashing to KISS FC firmware done.

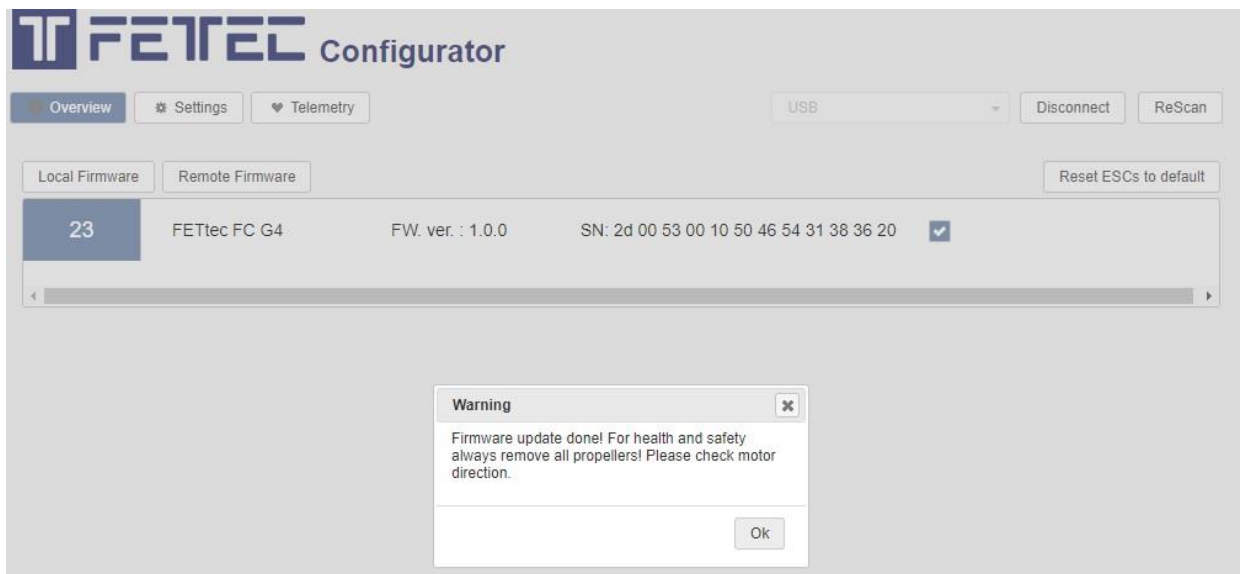

## FC firmware update

For firmware updates it is the same procedure as flashing the FETtec Alpha FC firmware. Connect FC via open port and choose “Firmware”.

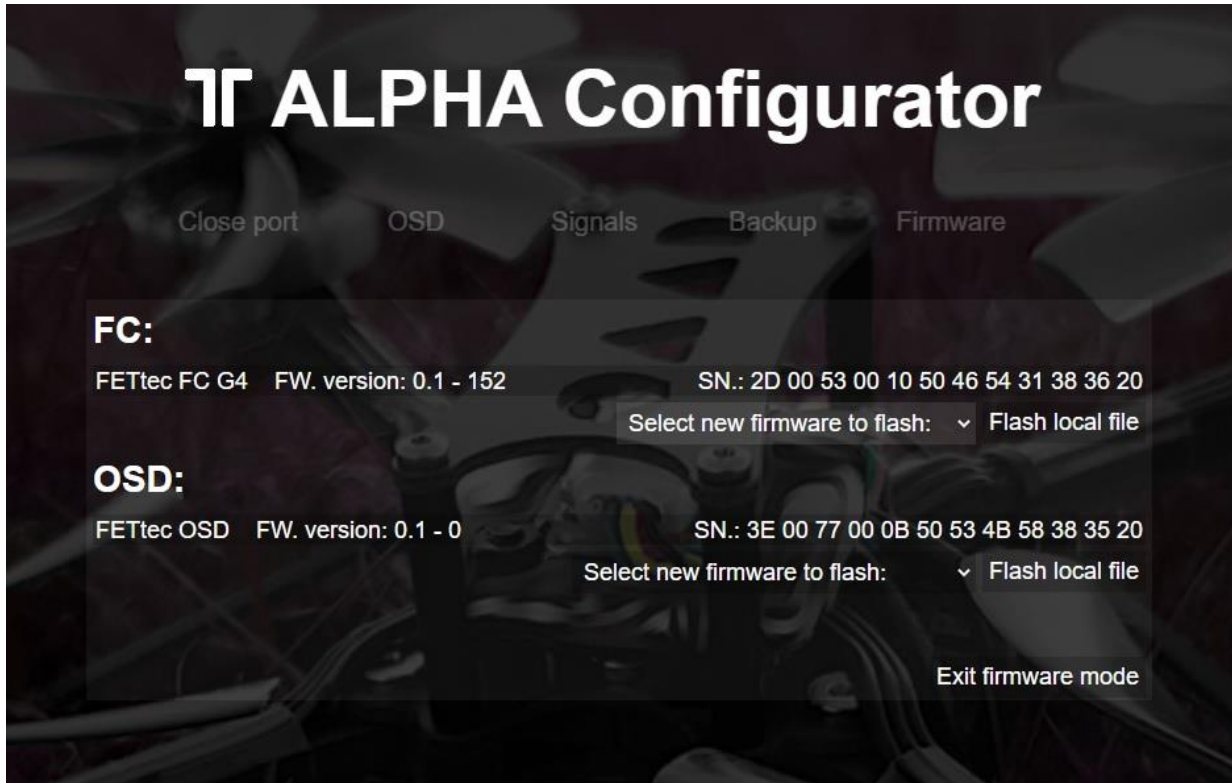

Now you can flash the latest firmware update via “Select new firmware to flash” or choose “Flash local file”.

We always recommend to use the latest available firmware to get the best user experience.

If you like to try new features and firmware developments you can join our Discord channel to be always up to date (<https://discord.gg/pfHAbahzRp>).

## Settings

You can set up the FC according to your wishes in the ALPHA Configurator.

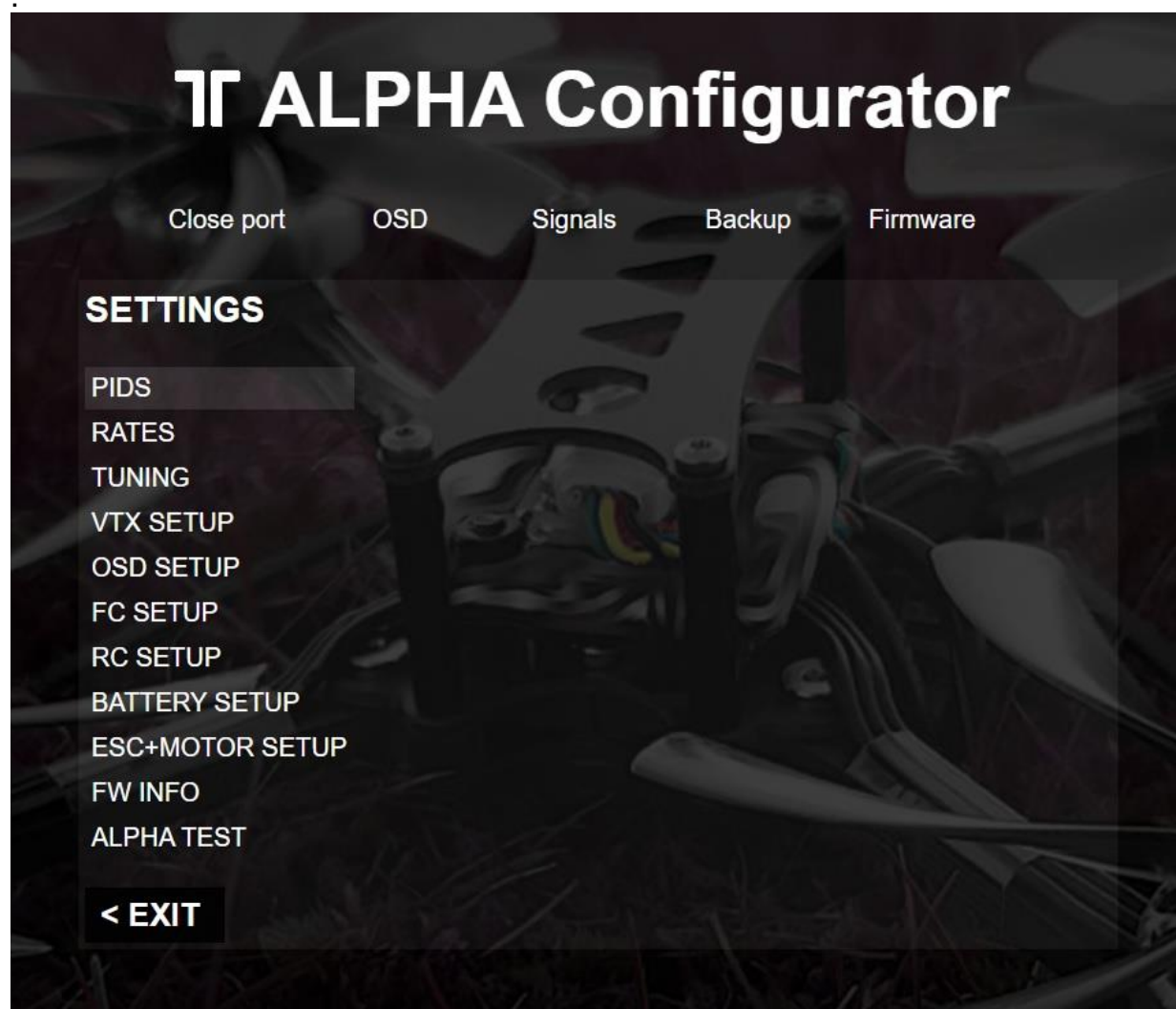

All functions are explained in the respective category.

For more information and help use the FETtec Alpha FC firmware manual available at [www.fettec.net/download](http://www.fettec.net/download)

## OSD

Please use the same respective firmware for FC and OSD (KISS or FETtec Alpha), otherwise it will not work

### **Update**

To update the FETtec OSD connect FETtec FC G4 v1.7 to ALPHA Configurator and flash via "Firmware" the latest update.

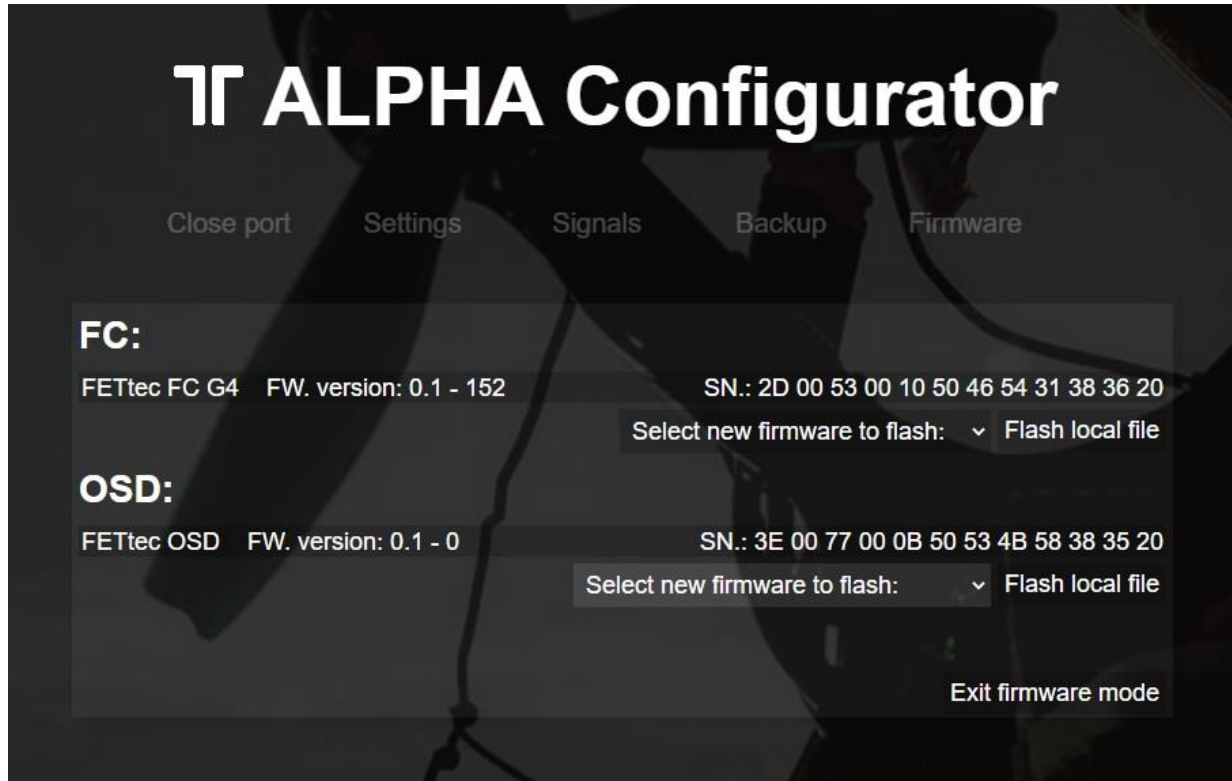

## Settings

In the settings of the ALPHA Configurator you can choose “OSD Setup”

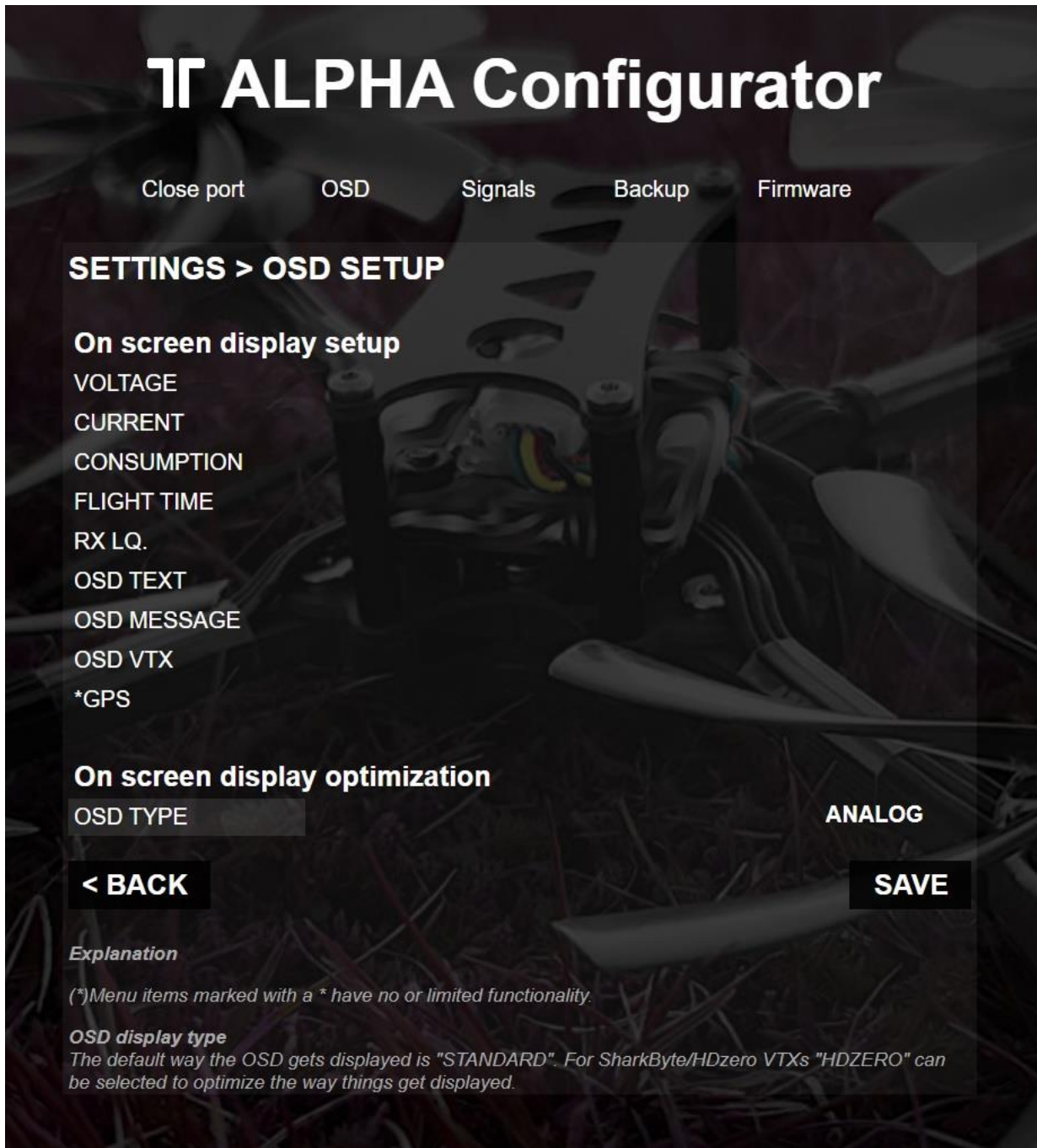

All parts of the OSD can be enabled/disabled and selected in their position.

Please read the explanations in the area below to be sure what the changes do.

All setting can easily be set and checked in the overview “OSD”

Here you can get an overview of how the selected settings look in the OSD

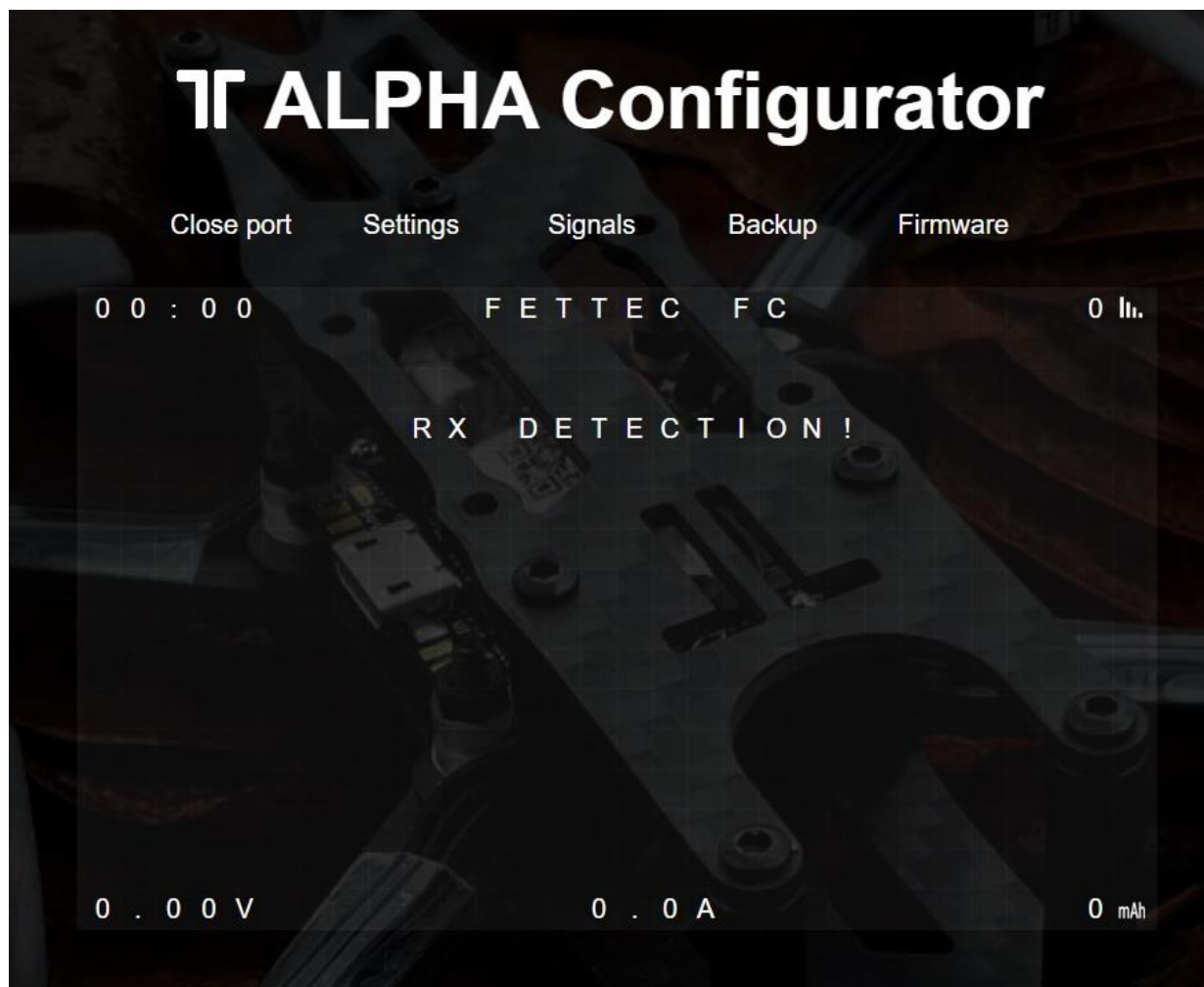

The OSD settings can also be set directly in the goggles as noted on page 17.

## Display connection

I2C O-LED to FETtec FC G4

I2C O-LED display can be used to show the OSD menu and telemetry in order to be able to set up settings without computer or FPV goggles (FPV OSD).

The I2C connection will block serial 3 which is mostly used for digital OSD or analog VTX control (VCS).

The O-LED must be connected on power up to initialize but can be unplugged after set up is done.

Supported display types:

I2C OLED (SSD1306 or SSH1106 chip)

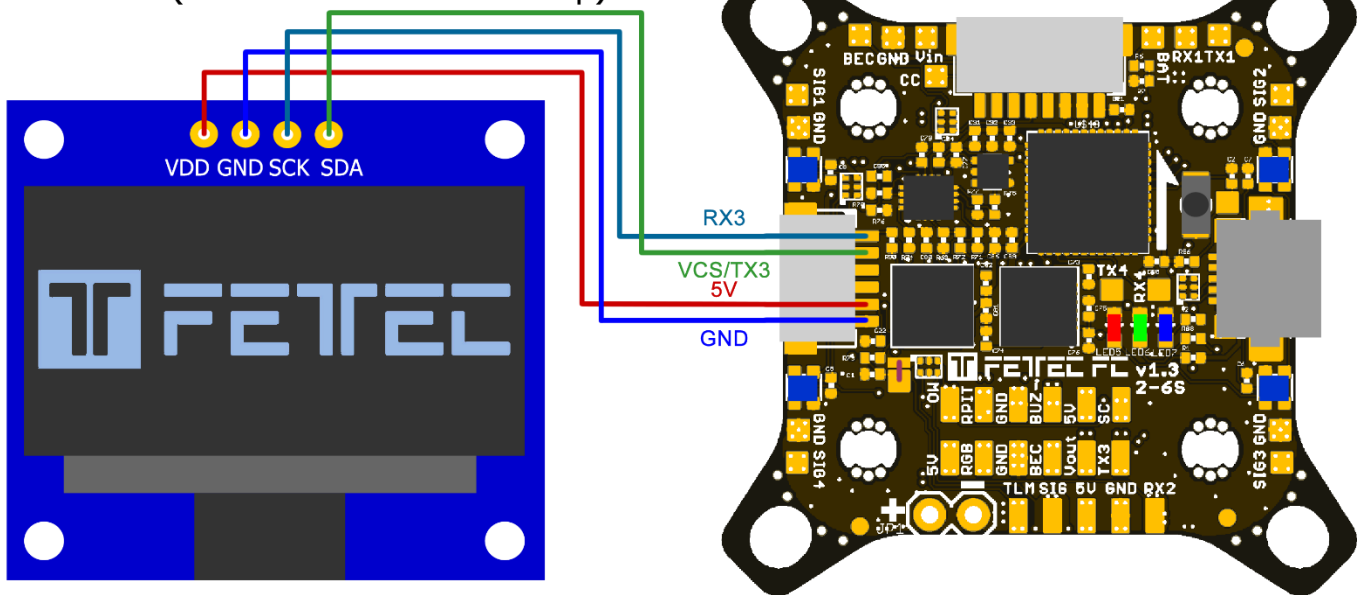

Required resolution 128 x 64px

We recommend the 1,3" (SSH1106) version as the text size will be very small on the 0,96" (SSD1306) display.



## Activation in FETtec Alpha FC firmware

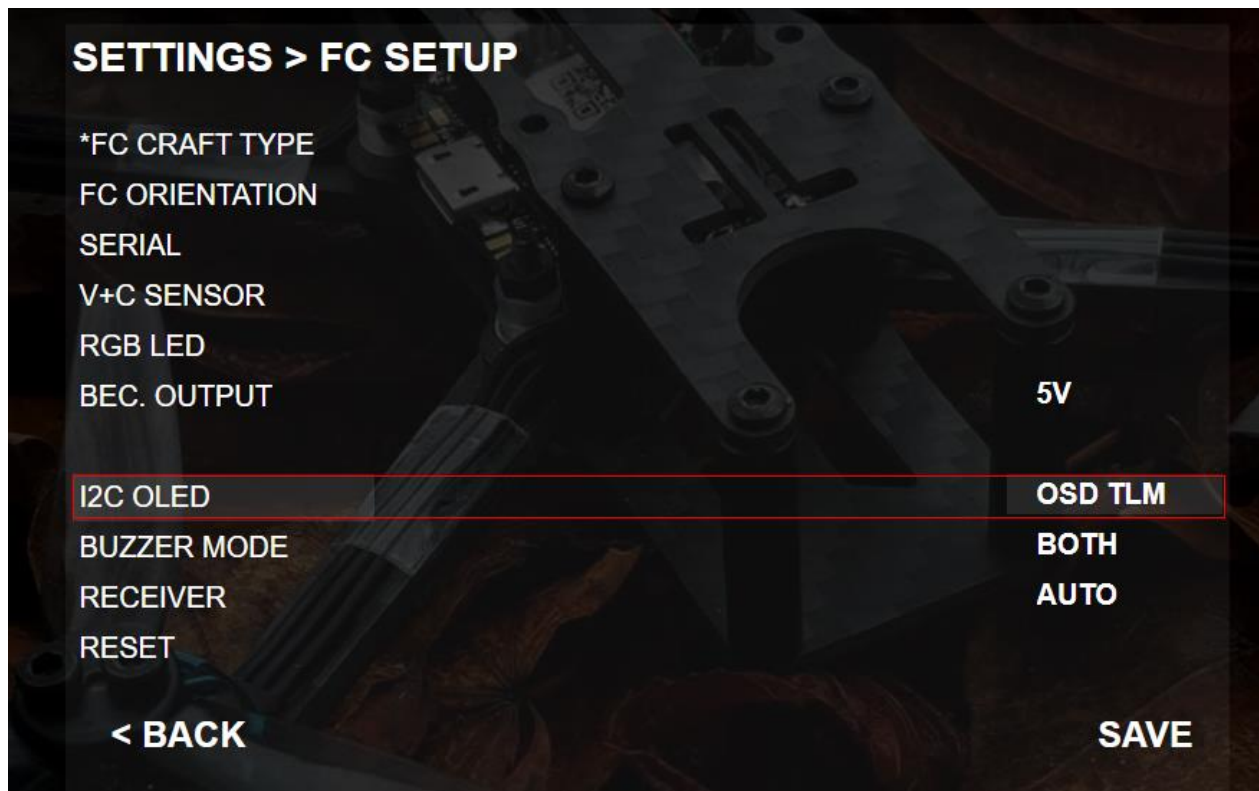

## Dimensions

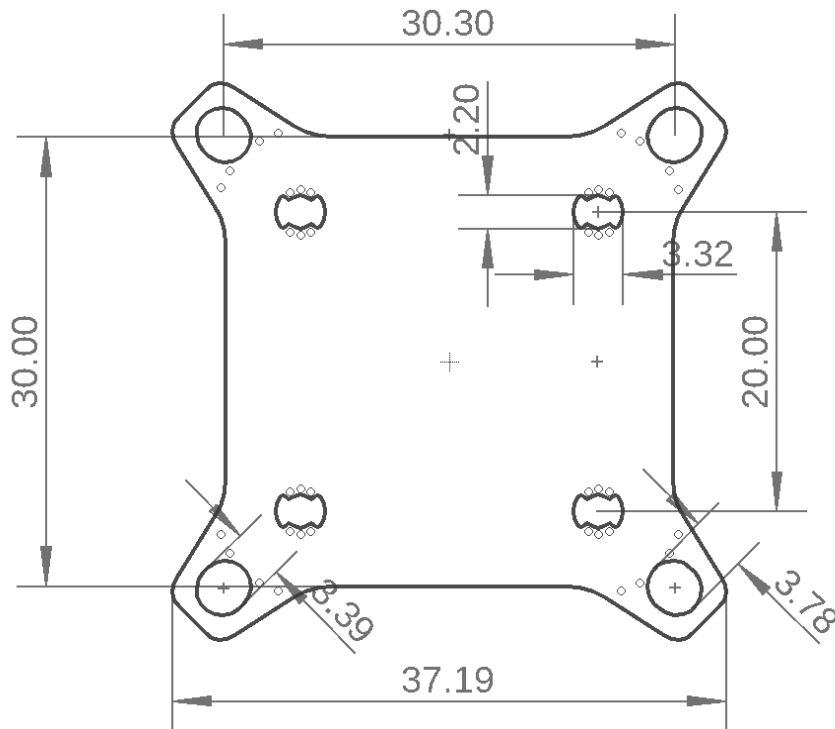

Maximum outside dimensions: 37,2 x 37,2mm, without outside tips 30 x 30mm

Mounting hole arrangement:

- 20 x 20mm with M2 mounting hole (expandable to M3)
- 30 x 30mm with M3 mounting hole
- 30 x 30mm mounting hole tips are removable to reduce overall FC size

Overall height: 7,9mm

Highest part on each PCB side: 3,2mm

Weight: 5,37g

Do not file the mounting holes as this may cause damage!